

DEVELON

Crawler Excavator

DX1000LC-7



Engine

Make	Perkins
Model	2806J
Number of cylinders	6
Rated power, gross (hp per SAE J1995)	629 hp (469 kW) @ 2000 rpm
Max. torque, gross (SAE J1995)	2178 ft.-lb. (2951 Nm) @ 1300 rpm
Piston displacement	1105 in. ³ (18.1 L)
Bore and stroke	5.7 in. x 7.2 in. (145 mm x 183 mm)
Starter	24 V, 12 hp (9.0 kW)
Battery	2 x 12 V, 200 AH
Alternator	24 V, 115 A
Air cleaner	Three-stage

Hydraulics

Main pumps	3 x 138 gpm (3 x 523 L/min.)
Pilot pump (gear design)	15.9 gpm (60 L/min.)

Working Pressure

Boom/arm/bucket (normal mode)	5076 psi (357 kg/cm ²)
Travel	5076 psi (357 kg/cm ²)
Swing	4270 psi (300 kg/cm ²)
Pilot	2901 psi (204 kg/cm ²)

Undercarriage

Upper rollers (each track)	3
Lower rollers (each track)	9
Number of shoes (links per side)	51

Swing Mechanism

Swing speed	0 – 6.3 rpm
Swing torque	284474 lbf.-ft. (39330 kgf-m)

Drive System

Travel speed (low – high)	1.6 – 2.7 mph (2.6 – 4.3 km/h)
Traction force, max. (drawbar pull)	173504 lbf.-ft. (78700 kgf-m)
Max. grade (limited by engine lubrication)	70% (35°)

Environment

Sound level (2000/14/EC)	109 dB(A)
Cabin sound level (ISO 6396)	71 dB(A)

Refill Capacities

Fuel tank	300.6 gal. (1138 L)
DEF tank	12.4 gal. (47 L)
Cooling system (radiator capacity)	27.5 gal. (105.1 L)
Engine oil (with filler)	17.2 gal. (65 L)
Swing drive	2 x 2.1 gal. (2 x 8 L)
Final drive (each side)	5.3 gal. (20 L)
Hydraulic system	233 gal. (881 L)
Hydraulic tank	141 gal. (533 L)

Hydraulic Cylinders

Boom (2) bore x rod diameter x stroke	8.5 in. x 5.9 in. x 75 in. (215 mm x 150 mm x 1905 mm)
Arm (1) bore x rod diameter x stroke	9.4 in. x 6.7 in. x 79.5 in. (240 mm x 170 mm x 2020 mm)
Bucket (1) bore x rod diameter x stroke	STD 8.3 in. x 5.7 in. x 60.2 in. (210 mm x 145 mm x 1530 mm)
	ME* 8.9 in. x 6.3 in. x 60.2 in. (225 mm x 160 mm x 1530 mm)

*ME: Mass Excavation arm

The piston rods and cylinder bodies are made of high-strength steel. A shock-absorbing mechanism is fitted in all cylinders to ensure shock-free operation and extended piston life.

Dimensions

		Standard Arm 36" (900 mm) DG Shoe (US20)	Mass Excavation 36" (900 mm) DG Shoe (US40)
Boom length		27' 7" (8400 mm)	23' 9" (7250 mm)
Arm length		12' 4" (3750 mm)	9' 6" (2900 mm)
Bucket type (SAE)		7.06 yd ³ (5.4 m ³)	8.89 yd ³ (6.8 m ³)
Track type		Retractable	
Tail swing radius	A ₁	15' 2" (4620 mm)	
Tail swing overhang (rear)	A ₂	4' 7" (1395 mm)	
Tail swing overhang (side)	without step	8' 1" (2465 mm)	
	with step	7' 7" (2319 mm)	
Shipping height (boom)	B	17' 11" (5450 mm)	16' 8" (5090 mm)
Shipping height (hose)	C	18' 3" (5550 mm)	16' 11" (5150 mm)
Shipping length	D	47' 9" (14550 mm)	45' 3" (13800 mm)
Shipping width (with step)	E	13' 1" (3982 mm)	
Counterweight clearance*	F	5' 1" (1560 mm)	
Cabin height	G	11' 10" (3615 mm)	
Upper structure width	without catwalks	11' 2" (3410 mm)	
	with catwalks	14' 7" (4450 mm)	
Cabin height above house	I	-	
Cabin width	J	3' 4" (1010 mm)	
Tumbler distance	K	16' 9" (5100 mm)	
Overall track length	L	20' 10" (6341 mm)	
Undercarriage width (without step)	retracted	12' 1" (3690 mm)	
	extended	14' 7" (4450 mm)	
Undercarriage width (with step)	retracted	13' 1" (3982 mm)	
	extended	15' 7" (4742 mm)	
Track gauge (extended)	N	11' 8" (3550 mm)	
Track shoe width	O	36" (900 mm)	
Track height	P	4' 9" (1452 mm)	
Car body clearance*	Q	2' 10" (860 mm)	

*Without grouser height (55 mm)
Less than zero indicated as "-"

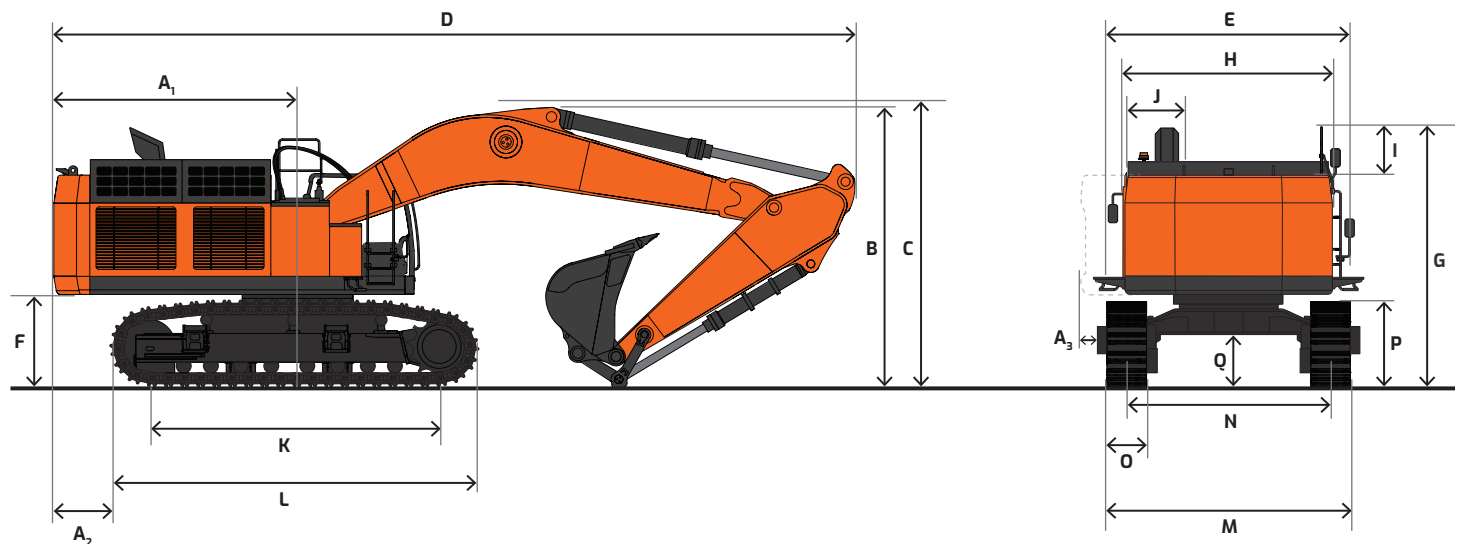

Working Range

		Standard Arm 36" (900 mm) DG Shoe (US20)	Mass Excavation 36" (900 mm) DG Shoe (US40)
Boom length		27' 7" (8400 mm)	23' 9" (7250 mm)
Arm length		12' 4" (3750 mm)	9' 6" (2900 mm)
Bucket type (SAE, PCSA)		7.06 yd ³ (5.4 m ³)	8.89 yd ³ (6.8 m ³)
Track type		Retractable	
Max. digging reach	A	46' 10" (14275 mm)	40' 9" (12430 mm)
Max. digging reach (ground)	B	45' 11" (14000 mm)	39' 9" (12110 mm)
Max. digging depth	C	28' 10" (8795 mm)	23' 10" (7260 mm)
Max. loading height	D	31' 0" (9440 mm)	26' 7" (8100 mm)
Min. loading height	E	13' 10" (4210 mm)	12' 10" (3910 mm)
Max. digging height	F	45' 5" (13840 mm)	40' 9" (12425 mm)
Max. bucket pin height	G	38' 11" (11862 mm)	34' 6" (10515 mm)
Max. vertical wall depth	H	14' 8" (4470 mm)	9' 9" (2965 mm)
Max. radius vertical	I	40' 3" (12265 mm)	36' 1" (10995 mm)
Max. depth to 8' line	J	28' 5" (8665 mm)	23' 4" (7110 mm)
Min. radius to 8' line	K	17' 4" (5290 mm)	14' 6" (4410 mm)
Min. digging reach	L	11' 0" (3365 mm)	6' 6" (1970 mm)
Min. swing radius	M	20' 8" (6295 mm)	17' 6" (5345 mm)
Bucket angle (DEG)	d	143.8°	145.3°
Digging force, bucket (PCSA)	ISO	88185 lbf. (40000 kgf)	98767 lbf. (44800 kgf)
Digging force, arm		79850 lbf. (36220 kgf)	88846 lbf. (40300 kgf)
Operating weight		220880 lb. (100400 kg)	220282 lb. (100128 kg)
Ground pressure		14.4 psi (1.01 kg/cm ²)	

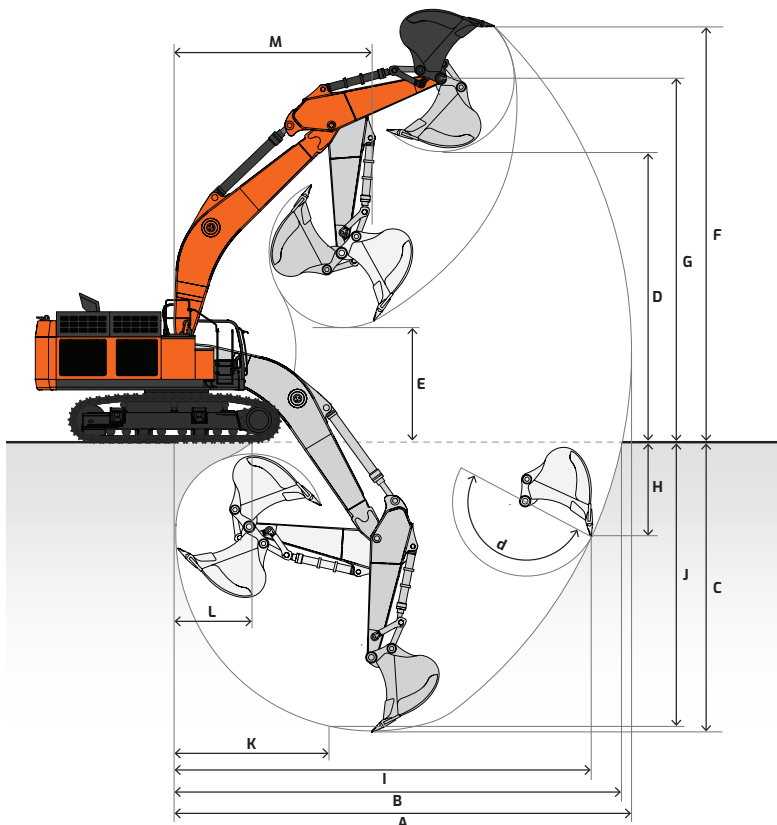

Bucket

	Standard Arm (US20)	Mass Excavation (US40)
Boom	27' 7" (8400 mm)	23' 9" (7250 mm)
Arm	12' 4" (3750 mm)	9' 6" (2900 mm)
Shoe size	36" (900 mm)	
Track type	Retractable	
Mount	Pin-on	
Removeable counterweight	24860 lb. (11300 kg)	

Bucket Type	Capacity* – yd ³ (m ³)		Width – in. (mm)	
	CECE	SAE	with cutter	without cutter
Heavy-duty	6.4 yd ³ (4.9 m ³)	7.06 yd ³ (5.4 m ³)	76.37" (1940 mm)	
	7.97 yd ³ (6.1 m ³)	8.8 yd ³ (6.8 m ³)	91.3" (2320 mm)	

Bucket Type	Capacity* – yd ³ (m ³)		650 Shoe		750 Shoe		900 Shoe	
	CECE	SAE	US20	US40	US20	US40	US20	US40
Severe-duty	6.4 yd ³ (4.9 m ³)	7.06 yd ³ (5.4 m ³)	D	A	D	A	D	A
	7.97 yd ³ (6.1 m ³)	8.8 yd ³ (6.8 m ³)	X	C	X	C	X	C

*Capacity based on ISO 10567 and SAE J296, arm length without quick change clamp

- Equipped with bolt-on wear shrouds
- Equipped with bolt-on teeth
- Equipped with bolt-on cutting edge
- These recommendations are given as a guide only and based on typical operating conditions.

Maximum Suitable Material Density

- A 3500 lb./yd³ (2100 kg/m³)
- B 3000 lb./yd³ (1800 kg/m³)
- C 2500 lb./yd³ (1500 kg/m³)
- D 2000 lb./yd³ (1200 kg/m³)
- X Not Recommended













Please consult with your DEVELON dealer to properly match buckets and attachments for the application.

Lifting Capacity

 Rating over front  Rating over side or 360°

DX1000LC-7 US20

Boom: 27' 7" (8400 mm) | Arm: 12' 4" (3750 mm) | Counterweight: 24860 lb. (11300 kg) | 36" (900 mm) Double Grouser | No Dozer | Bucket: None | Unit: lb. (kg)

A (ft. or m) B (ft. or m)	15' (4.5 m)		20' (6.0 m)		25' (7.5 m)		30' (9.0 m)		35' (10.5 m)		Max. Reach		
													A
35' (10.5 m)							* 33690 (* 15280)	* 33690 (* 15280)			* 32320 (* 14660)	* 32320 (* 14660)	29.70' (9.05 m)
30' (9.0 m)							* 35690 (* 16190)	* 35690 (* 16190)			* 30690 (* 13920)	* 30690 (* 13920)	33.36' (10.17 m)
25' (7.5 m)					* 40750 (* 18480)	* 40750 (* 18480)	* 36950 (* 16760)	* 36950 (* 16760)	* 34770 (* 15770)	33860 (15360)	* 30070 (* 13640)	* 30070 (* 13640)	35.98' (10.97 m)
20' (6.0 m)					* 45060 (* 20440)	* 45060 (* 20440)	* 39280 (* 17820)	* 39280 (* 17820)	* 35710 (* 16200)	33070 (15000)	* 30160 (* 13680)	28030 (12710)	37.75' (11.50 m)
15' (4.5 m)					* 50010 (* 22680)	* 50010 (* 22680)	* 42110 (* 19100)	40830 (18520)	* 37200 (* 16870)	31990 (14510)	* 30880 (* 14010)	26120 (11850)	38.80' (11.83 m)
10' (3.0 m)					* 54500 (* 24720)	50790 (23040)	* 44840 (* 20340)	38970 (17670)	* 38730 (* 17570)	30870 (14000)	* 32270 (* 14640)	25090 (11380)	39.21' (11.95 m)
5' (1.5 m)					* 57540 (* 26100)	48520 (22010)	* 46890 (* 21270)	37450 (16990)	* 39880 (* 18090)	29920 (13570)	* 34450 (* 15630)	24840 (11270)	38.98' (11.88 m)
Ground Level					* 58650 (* 26600)	47190 (21410)	* 47800 (* 21680)	36430 (16520)	* 40200 (* 18230)	29270 (13280)	* 35460 (* 16090)	25380 (11510)	38.11' (11.62 m)
-5' (-1.5 m)			* 72260 (* 32780)	65470 (29700)	* 57710 (* 26180)	46680 (21700)	* 47200 (* 21410)	35970 (16320)	* 39150 (* 17760)	29050 (13180)	* 35800 (* 16240)	26880 (12190)	36.55' (11.14 m)
-10' (-3.0 m)	* 83060 (* 37670)	* 83060 (* 37670)	* 67280 (* 30520)	66050 (29960)	* 54530 (* 24730)	46870 (21260)	* 44530 (* 20200)	36110 (16380)			* 35850 (* 16260)	29760 (13500)	34.19' (10.42 m)
-15' (-4.5 m)	* 72150 (* 32730)	* 72150 (* 32730)	* 59330 (* 26910)	* 59330 (* 26910)	* 48350 (* 21930)	47780 (21680)	* 38320 (* 17380)	37040 (16800)			* 35180 (* 15960)	35030 (15890)	30.88' (9.41 m)
-20' (-6.0 m)			* 46610 (* 21140)	* 46610 (* 21140)	* 36590 (* 16600)	* 36590 (* 16600)					* 32550 (* 14760)	* 32550 (* 14760)	26.19' (7.98 m)

A Distance from center of rotation
B Height

NOTE: Lifting capacities are in compliance with SAE 1097 and ISO 10567. Machine in lifting mode with power boost turned on. Load point is the end of the arm. Rated loads shown do not exceed 75% of minimum tipping loads or 87% of hydraulic capacities. Rated loads marked with an asterisk (*) are limited by hydraulic capacities. The least stable position is over the side. The total mass of machine includes the mass of the boom, arm, counterweight, all operating fluids and 165 lb. (75 kg) operator.

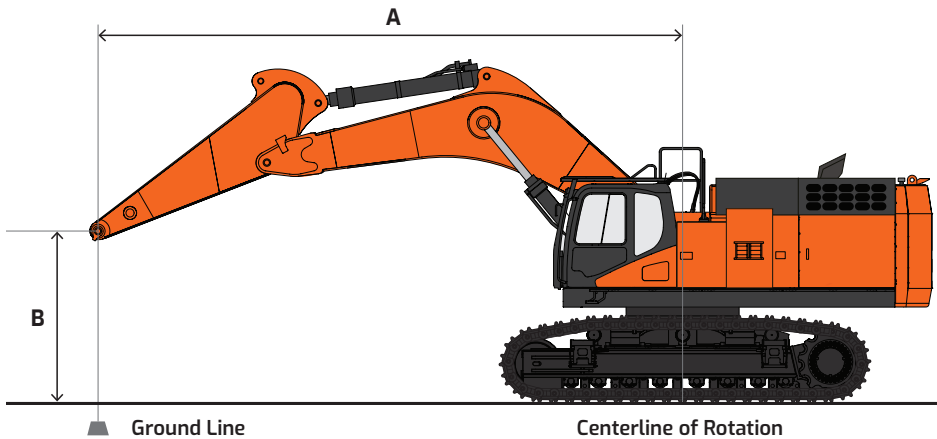











Lifting Capacity

 Rating over front  Rating over side or 360°

DX1000LC-7 US40

Boom: 23' 9" (7250 mm) | Arm: 9' 6" (2900 mm) | Counterweight: 24860 lb. (11300 kg) | 36" (900 mm) Double Grouser | No Dozer | Bucket: None | Unit: lb. (kg)

A (ft. or m) B (ft. or m)	15' (4.5 m)		20' (6.0 m)		25' (7.5 m)		30' (9.0 m)		Max. Reach		
											A
-35' (-10.5 m)									* 43780 (* 19860)	* 43780 (* 19860)	20.99' (6.40 m)
30' (9.0 m)					* 46570 (* 21120)	* 46570 (* 21120)			* 39360 (* 17850)	* 39360 (* 17850)	25.93' (7.90 m)
25' (7.5 m)					* 47040 (* 21340)	* 47040 (* 21340)			* 37570 (* 17040)	* 37570 (* 17040)	29.23' (8.91 m)
20' (6.0 m)			* 58870 (* 26700)	* 58870 (* 26700)	* 50180 (* 22760)	* 50180 (* 22760)	* 45440 (* 20610)	* 45440 (* 20610)	* 37210 (* 16880)	* 37210 (* 16880)	31.39' (9.57 m)
15' (4.5 m)			* 67560 (* 30640)	* 67560 (* 30640)	* 54530 (* 24730)	* 54530 (* 24730)	* 47320 (* 21460)	44400 -20140	* 37940 (* 17210)	37730 -17110	32.67' (9.96 m)
10' (3.0 m)			* 75130 (* 34080)	* 75130 (* 34080)	* 58720 (* 26640)	56260 -25520	* 49410 (* 22410)	43040 -19520	* 39750 (* 18030)	36120 -16380	33.15' (10.10 m)
5' (1.5 m)			* 79020 (* 35840)	75140 -34080	* 61510 (* 27900)	54350 -24650	* 50790 (* 23040)	41910 -19010	* 42890 (* 19460)	35950 -16310	32.88' (10.02 m)
Ground Level			* 78850 (* 35770)	73900 -33520	* 62030 (* 28140)	53250 -24160	* 50560 (* 22930)	41260 -18720	* 45810 (* 20780)	37280 -16910	31.84' (9.70 m)
-5' (-1.5 m)	* 95130 (* 43150)	* 95130 (* 43150)	* 75010 (* 34030)	73820 -33480	* 59610 (* 27040)	53010 -24050	* 47190 (* 21400)	41350 -18750	* 46020 (* 20870)	40640 -18430	29.94' (9.13 m)
-10' (-3.0 m)	* 83510 (* 37880)	* 83510 (* 37880)	* 66940 (* 30360)	* 66940 (* 30360)	* 52700 (* 23900)	* 52700 (* 23900)			* 45320 (* 20560)	* 45320 (* 20560)	27.00' (8.23 m)
-15' (-4.5 m)	* 64800 (* 29390)	* 64800 (* 29390)	* 51600 (* 23410)	* 51600 (* 23410)					* 41910 (* 19010)	* 41910 (* 19010)	22.61' (6.89 m)

A Distance from center of rotation
B Height

NOTE: Lifting capacities are in compliance with SAE 1097 and ISO 10567. Machine in lifting mode with power boost turned on. Load point is the end of the arm. Rated loads shown do not exceed 75% of minimum tipping loads or 87% of hydraulic capacities. Rated loads marked with an asterisk (*) are limited by hydraulic capacities. The least stable position is over the side. The total mass of machine includes the mass of the boom, arm, counterweight, all operating fluids and 165 lb. (75 kg) operator.

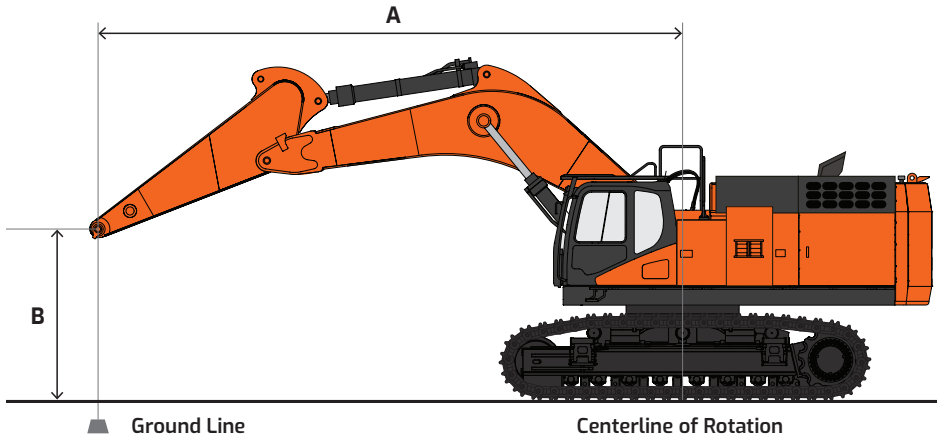

Standard & Optional Equipment

■ Standard • Optional

Engine

Perkins 2806J	■
Stage V compliant	■
Turbo, waste gate (WGT)	■
Air-to-air intercooler	■
Selective catalyst reduction (SCR)	■
Diesel oxidation catalyst (DOC)	■
Diesel particulate filter (DPF)	■
Three-stage air cleaner (cyclonic pre-filter & 2 filter elements)	■

Hydraulic

Pilot-operated control valves	■
Pattern control change valve	■
Removable counterweight system	■
Variable-speed hydraulic cooling fan	■
Axial piston swing motors	■
Auxiliary hydraulics, one- & two-way piping with pedal	■
Auxiliary hydraulics, rotate piping	■
Quick coupler piping	■
Adjustable auxiliary flow & pressure, 10 presets	■
Intelligent floating boom	■
Breaker return filter	■
Boom & arm lock valves	■
Boom & arm flow regeneration	■
Straight travel	■

Controls

Proportional control for auxiliary hydraulics, roll switch on both joysticks	■
Limp home mode control switch	■
Auto idle control system, one-touch deceleration button on joystick	■
Engine speed control dial	■
Advanced mechatronics with power mode control system	■
Power modes (P+, P, S, E)	■
Work modes (excavating, lifting, breaker, shear)	■
Jog dial display control	■
Electronic Power Optimizing System (EPOS)	■
Cross-sensing pump control	■

Cabin

Steel, all-weather & sound-suppressed	■
Vandalism guard hooks	■
Viscous mount with spring reinforcement	■
Front window with wiper/washer	■
Tinted safety glass	■
Skylight top hatch with sun screen	■
Pull-up type top front window	■
Removable lower front window with storage behind seat	■
Adjustable sliding side door window	■
Defrost, front window	■
Seat	■
- Heated	■
- Air suspension	■
- 2" (51 mm) seat belt	■
- Adjustable height & recline	■
- Adjustable fore/aft	■
- Adjustable armrests	■
- Adjustable lumbar	■
Leatherette seat	■
- Heating & cooling	■
- Air suspension	■
- 2" (51 mm) seat belt	■
- Adjustable height & recline	■
- Adjustable fore/aft	■
- Adjustable armrests	■
- Adjustable lumbar	■
- Adjustable headrest	■
- Adjustable bottom cushion	■
- Height adjustable panels	■
- Sliding control console	■
Fully automatic HVAC with ambient temperature sensor	■
8" multi-function LCD interactive display monitor	■
Digital Bluetooth® audio broadcasting MP3 radio with cell phone integration	■
- Audio control panel on/off switch	■
- Control volume	■
- Channel select	■
Antenna, roof-mounted	■
Emergency breakout tool	■
Cup holder	■
Shoe case	■
Coat hanger	■
Rain shield	■
Fog guard	■
Front window guard	■

Electrical

System voltage – 24 V	■
Alternator – 24 V, 115 amp	■
2 x 12 V batteries, 200 AH reserve capacity	■
Main circuit breaker	■
Power sockets – 12 V & 24 V	■
Electrical remote box with spare fuses & spare relays	■
LED lights: machine (2), boom (2)	■
Light, work (LED): 8	■
Rotating beacon	■
Overload warning alarm	■
Hour meter	■
Engine restart prevention system	■
Side view & rearview camera with LED lamps (3)	■
360° all-around view camera	■
Laptop service port	■
Self-diagnostics system	■
Smart key (remote ignition key)	■
Emergency stop switch	■
Swing alarm	■
Travel alarm	■
Lower window wiper	■
DEVELON Fleet Management	■

Undercarriage

Track guards & chains with adjusters	■
Track rollers, upper	3
Track rollers, lower	9
Shoes, double grouser – 600 mm	■
Shoes, double grouser – 750 mm	■
Shoes, double grouser – 900 mm	■

Other

Automatic lubrication	■
Handrails & service platforms	■
Skid-resistant steps & service platforms, upper deck	■
DEVELON Fleet Management 3-year subscription	■
Air compressor	■

DEVELON

na.develon-ce.com

DX1000LC-7 Crawler Excavator Spec Sheet
Printed in the U.S.A.
23906_001_D041123

©2023 HD Hyundai Infracore. All rights reserved.
DEVELON is a brand of HD Hyundai Infracore;
HD Hyundai Infracore is an affiliate of HD Hyundai.